

SyncServer S250

GPS Network Time Server with Timing Enhancements

KEY FEATURES

- High-Bandwidth NTP Time Server
- Stratum 1 Operation Via GPS Satellites
- 50 Nanosecond Time Accuracy to UTC
- 3 Independent 10/100Base-T Ports
- High-Resolution Vacuum Fluorescent Display
- Full Numeric Keypad
- IPv6 and IPv4 Compliant
- Secure Web-Based Management
- SSH, SSL, SCP, SNMP v3, Custom MIB, HTTPS, Telnet, and More
- Dual USB Ports
- Independent Time References: GPS, IRIG B, 1PPS, 10 MHz
- Versatile Timing Outputs: IRIG B, 1PPS, 10 MHz, Sysplex
- Two-Year Warranty
- Rubidium & OCXO Oscillator Upgrades
- S250i Model With No GPS

KEY BENEFITS

- Synchronize Thousands of Client Clocks
- Extremely Accurate Reference for Network Time Synchronization and Time & Frequency Applications
- Automatic, Prioritized Reference Selection Between GPS, IRIG B, 1PPS & 10 MHz
- Very Easy to Configure a Cesium Standard as Backup for GPS
- Multiple NTP Ports for Easy Network Configuration and Adaptation
- Intuitive Web Interface for Easy Control & Maintenance
- IPv6 Compliance Futureproofs Your Network

The SyncServer® S250 Precision GPS Network Time Server synchronizes clocks on servers for large or expanding networks and for the ever-demanding high-bandwidth Next Generation Network. Accurately synchronized clocks are critical for network log file accuracy, security, billing systems, electronic transactions, database integrity, VoIP, and many other essential applications.

The S250 is the easiest to set up and maintain network time server in the world. The front panel is designed to quickly bring the time server online with a few front panel keystrokes or DHCP. To fully configure the unit, use the very intuitive web interface. The S250 is also the first network time server to offer step-by-step wizards for the most common operations. The state-of-the-art user interface offers the network administrator ease-of-use and remote access, with intuitive web pages and full control of the server via a standard browser interface.

Once online, the S250 provides reliable and secure network synchronization technology by combining multi-port, high-speed/ high capacity network interfaces and versatile GPS timing receiver technology. It supports a wide range of network protocols including IPv4 and IPv6, for easy management and seamless integration into your existing and future network.

The high availability and throughput of the three 10/100Base-T ports translates into the support of hundreds of thousands of network clients while maintaining microsecond caliber NTP timestamp accuracy. They also provide the flexibility needed to easily adapt to different and changing network topologies and security requirements.

The Stratum 1 S250 will automatically synchronize to GPS, IRIG B AM, 1PPS, and 10 MHz in that priority. It smoothly transitions from one reference to the next available if the higher priority signal is lost or regained. This is perfect for operating with different backup time or frequency sources. The S250 can also revert to a Stratum 2 mode and retrieve time from other user-designated time servers. Similarly the S250 generates IRIG B, 1PPS and 10 MHz outputs and can be upgraded to an internal Rubidium atomic oscillator. While tracking GPS the S250 is accurate to 50 nanoseconds to UTC.

The SyncServer S250 is your answer to bringing perfect timing to your network.



S250 NETWORKING EXCELLENCE

Unmatched Performance with Unparalleled Flexibility

The S250 has three dedicated and isolated 10/100Base-T Ethernet ports. These are connected to a high-speed microprocessor and a 50 nanosecond accurate clock to assure high bandwidth NTP performance. This more than meets the need of servicing 3200 NTP requests per second while maintaining microsecond caliber timestamp accuracy.



Three network ports provide network configuration flexibility and enhanced security. "Multiple" isolated and synchronized time servers can also be configured.

Three Ports for Flexibility and Security

Multiple ports provide the flexibility to adapt to different network topologies as networks grow and change. An S250 can be the single time source to synchronize clients that are on different subnets and different physical networks. It is also an ideal solution for synchronized time on in-band and out-of band networks. Since each port is independent, it can appear as though there are three clocks available, even though there is only a single time reference.

BEST PRACTICES

- Two time servers provide redundant time source protection for time clients.
- Peering between time servers assures time continuity to time clients if GPS is not available.
- Always configure time clients to reference at least two time servers.
- Increase network security by serving time via ports 2 and 3 and reserving port 1 for server management only.

In security sensitive networks we suggest using one port for maintenance and control functions and the other two ports for NTP timing functions only. This way the control port IP address information can be kept private and not distributed with the NTP addresses. IP address access control lists for each port also add enhanced security.

Extensive Protocol Support for Easy Network Integration and Management

All of the expected network management and monitoring protocols are standard in the S250. Secure access protocols such as SSH, SSL, HTTPS, along with legacy protocols such as DHCP and Telnet are included to provide you a choice in server management. SNMP v3 with a custom MIB allows you to automatically monitor the S250 and be advised of any important status changes. Any of these protocols can be quickly and easily disabled via the web based management interface.

Futureproof Your Network

The S250 supports both IPv4 and IPv6. The S250 works whether you are using IPv4, IPv4/IPv6 mixed-mode, or the IPv6 environment. This means your S250 can scale with your network operations and provide value for many years to come.

Automatic Software Upgrade Availability Notification

The S250 can periodically check the Symmetricom web site for newer versions of firmware. If a newer version is available, an informational SNMP trap or email is sent along with a status message in the web interface.

Point & Click Software Upgrades

Upgrading the firmware in the S250 is easy. Just browse to identify the firmware file and click the upload button. It is just as simple to backup and restore the server configuration files. This intuitive approach simplifies server management.

Time Server Log Files

A running log of activity and server configuration changes is maintained for later reference.

Examples of Network Timing Configurations



Basic configuration

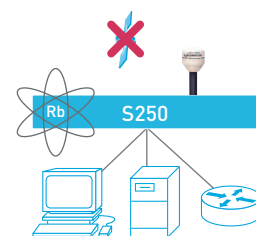

Resilient configuration incorporating a Rubidium Oscillator for improved holdover performance.

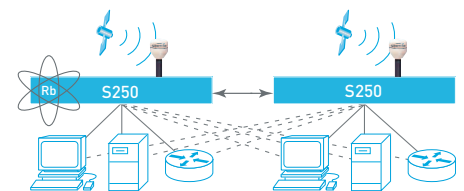

Redundant, resilient and secure configuration incorporating a Rubidium Oscillator in the primary server and peering to another server for backup redundancy.

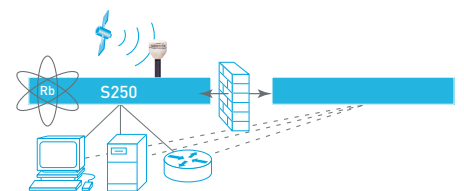

Resilient internal configuration. However, security, accuracy and reliability risks exist when peering with an external time server through the firewall.

S250 ADVANCED AND FUNCTIONAL DESIGN

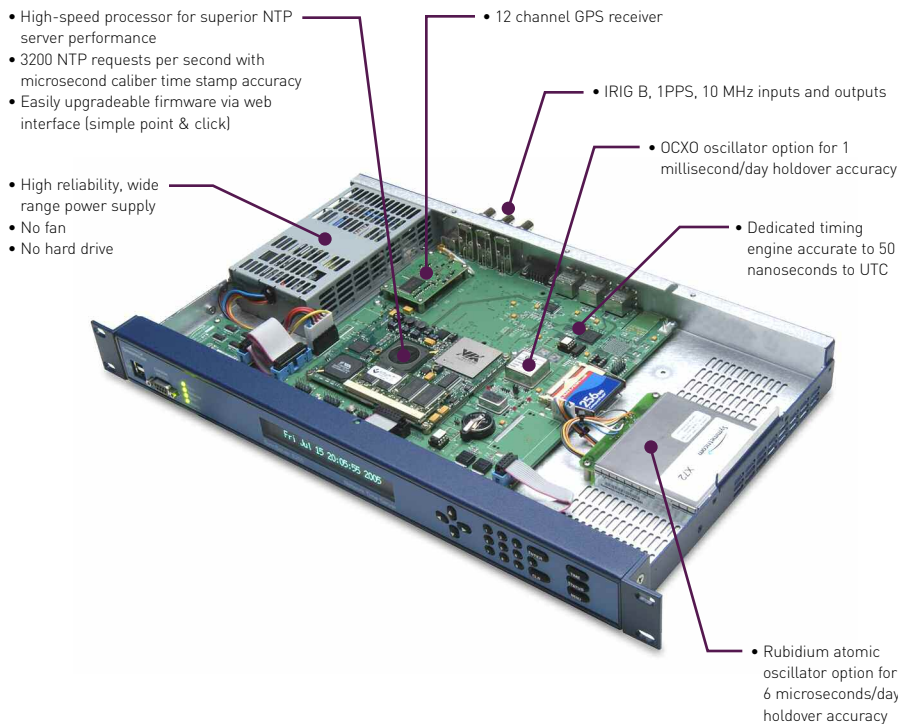

Customer Tested Design

As a 5th generation Symmetricon time server, the S250 has decades of design experience behind it. Customer input is evident in every detail. The front panel is designed for quick setup, informative clear presentation of time and status, and convenient physical access to the console ports. The rear panel is configured with those connections that are changed infrequently, such as power, GPS antenna, and network ports.

Control At Your Finger Tips

The physical interface on the S250 has been developed and tested with the



The full numeric keypad is the most efficient way to navigate a menu driven interface. The [TIME] & [STATUS] buttons quickly display the most critical information.

customer in mind. Keypad operation is quick and easy when using the full numeric keypad and control keys. You can cycle through different time formats by pressing the [TIME] key or get detailed status information by pressing the [STATUS] key. The S250 offers front panel menu control via the [MENU] button.

Quick and Easy Installation

The S250 has been optimized for quick setup via the keypad, requiring a minimum number of keystrokes. Just enter the basic network parameters or select DHCP and the unit is online. Once online, the web interface is the best and easiest way to customize the time server.

Primary configuration and management of the S250 is done via the intuitive and easy-to-use web interface. It is the first time server that offers wizards to streamline common setup and management tasks. No other time server is available with such an effortless interface that provides intuitive navigation and depth of control.

Crisp, Clear & Bright Display

Whether you need to view time information close-up or far away, the 256x32 high-resolution, variable intensity vacuum fluorescent display provides high visibility time and status in a variety of user selectable formats. The 1, 2 or 4 line display of data makes for a crystal clear time display along with an informative presentation of important configuration information.

At-A-Glance Status LEDs

LEDs present an excellent quick indicator of server status. The four LEDs provide status of the time reference (such as GPS), the network connection status, NTP operational status and request activity, and any existing alarm situation.



Crisp and bright vacuum fluorescent display offers high readability both near and far. Characters can be large, medium or small. Intensity is user adjustable.



Informative Status LEDs provide at-a-glance health of the network time server. The USB ports add additional flexibility in back-up, restore and upgrade operations.

BEST PRACTICES

- A full numeric keypad with a display makes for quick initial setup and installation.
- Most interactions with a time server are remote and are best served with a full featured web interface and good SNMP support.

S250 FULL-FEATURED WEB INTERFACE

Intuitive, Easy-to-Use and Secure

The S250 is designed to have the web interface be the primary status and control console. It is organized in to logical groupings such as Status, Network, Timing, etc. The tabbed panels offer easy exploration of features and easy configuration of the server. Typical web interface conventions are followed so that operation is quickly mastered. Server access is password

protected, with optional SSL encryption for added security. The web interface is enabled only through Port 1 so that the user may choose to keep that port IP address private and secure while serving time from Port 2 and/or Port 3.

Built-in Help System

The complete S250 manual is built into the web interface. The manual opens in a separate browser window. It is organized to match the control buttons and tabs so

that information is quickly and easily found. On most pages there is a link directly to the manual page for that panel. In addition there are context sensitive rollover descriptors of various features and tabs on any given panel.

Full System Status and Log Files

An essential part of a time server is knowing the system status when you need to. The S250 provides a semi-customizable green/red/orange

light status with system messages for quick, at-a-glance information. Detailed status information is available on all of the major subsystems of the server via the tabbed panels in the Status section. Any alarms or critical alerts are quickly found on the Alarm panel. To examine operational events, the Log section of

protected, with optional SSL encryption for added security. The web interface is enabled only through Port 1 so that the user may choose to keep that port IP address private and secure while serving time from Port 2 and/or Port 3.

Wizards Speed Routine Server Configuration Tasks

The S250 is the first time server where wizards are available to guide you step-by-step through the more frequent or expected operations. From experience we know there are certain configuration activities that most customers will, at some point, want to perform with the server. These include initial set-up, configuring time source behaviors, back-up and restore operations, firmware upgrades, and more. The wizards make these operations very easy.

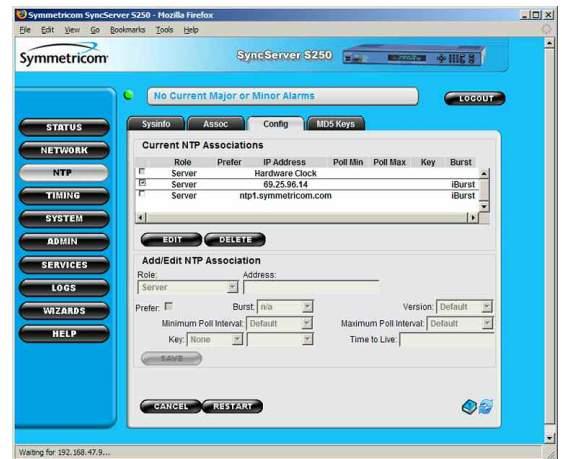

the web interface provides detailed listings of System, NTP, SNMP, HTTP, and Event activities.

BEST PRACTICES

- Configuring a time server is generally done once and seldom repeated. For that reason it should be easy to configure and maintain.
- A well-structured web interface is a preferred interface for a network device as it is intuitive, efficient, and easy to use.
- Consider the importance of quick and easy configuration back-up and restore operations, as well as the simplicity of firmware upgrades.
- Use of web wizards saves time and eliminates possible configuration conflicts. Configuration flexibility is also important, so consider how easy it is to configure advanced features.
- Turning on the auto-notification of firmware update availability assures awareness of current firmware revisions and critical product notifications.

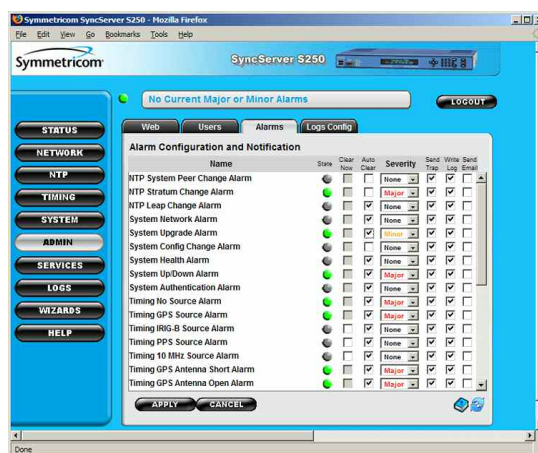

S250 PERFECT TIMING

Unprecedented Timing Accuracy

The Stratum 1 level S250 derives nanosecond accurate time directly from the atomic clocks aboard the GPS satellite system. By using an integrated, 12-channel GPS receiver, every visible satellite can be tracked and used to maintain accurate and reliable time. While tracking GPS the S250 is accurate to 50 nanoseconds to UTC. Beyond accurate NTP time stamping, this precision is excellent for generating the standard IRIG B AM, 1PPS and 10 MHz outputs.

The S250 can support hundreds of thousands of network clients while maintaining microsecond caliber NTP timestamp accuracy. NTP request throughput rates exceed 3200 requests/second while maintaining NTP timestamp accuracy. This easily translates into 0.5-2 ms typical client synchronization accuracy on a LAN.

Versatile Timing Configurations

The S250 will automatically synchronize to GPS, IRIG B AM, 1PPS, and 10 MHz references in that priority. It smoothly transitions from one reference to the next available if the higher priority signal is lost or regained. This is perfect

for operating with different backup time or frequency sources. A Rubidium or Cesium atomic frequency reference is often desired as a back-up to GPS. With the optional Rubidium oscillator the S250 will discipline that rubidium and lock to it if GPS is lost. Similarly, the S250 will seamlessly lock to the 10 MHz output of an external Cesium standard.

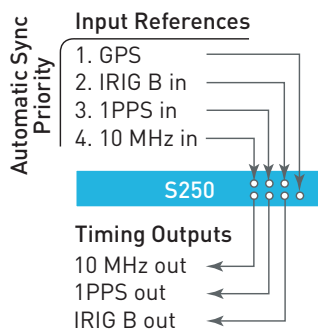

Alternative timing configurations include peering the S250 to other user designated time servers as a fallback time source to GPS. The S250 is also available without GPS in the S250i configuration.

Time Cross-Checking for Peace of Mind Reliability

The S250 can time cross-check the on-board GPS receiver against at least two other time servers. This protects against an improperly operating GPS receiver that can subtly corrupt the time.

Flexible Control Over System Timing Inputs and Outputs

By definition the S250 serves NTP in UTC format (or optionally in GPS timescale). However, the S250 can display local time rather than UTC time on the front panel (or optionally in GPS timescale). The time can also be set manually with an override on the NTP alarms so that it behaves as though it is tracking a legitimate time source, even though it is actually in holdover.



Sysplex Timer for Mainframe Sync

A dedicated Sysplex timer port outputs serial time strings for IBM mainframe Sysplex systems. The Sysplex Timer provides a common time reference across all the members of an IBM Sysplex. The Sysplex Timer is a key component when systems on multiple CPCs share access to the same data.

Oscillator Upgrades Improve Holdover Accuracy and Save You Valuable Time

The standard S250 is equipped with a temperature compensated crystal oscillator (TCXO), that keeps the S250 accurate to nanoseconds when tracking GPS. However, if the GPS signal is lost, thereby placing the server in holdover, the TCXO will soon drift away from perfect. Upgrading the oscillator improves the holdover accuracy significantly. For example, consider the one-day drift rates below:

Oscillator	Holdover Drift
TCXO	21 milliseconds per day
OCXO	1 milliseconds per day
Rubidium	6 microseconds per day

The value of the upgraded oscillator is that if the GPS signal is lost the S250 can continue to serve very accurate NTP time. This provides the IT staff plenty of time to correct the problem with no degradation or disruption in network time synchronization accuracy.

BEST PRACTICES

- Remember that accurate synchronization is directly related to how often the time clients update their time from the time server.
- Peering with other time servers is easy and provides a redundant source of time as a fallback.
- The optional Rubidium oscillator keeps the S250 extremely accurate while serving NTP in the event GPS service is interrupted.

Accumulated Drift Error by Oscillator Type

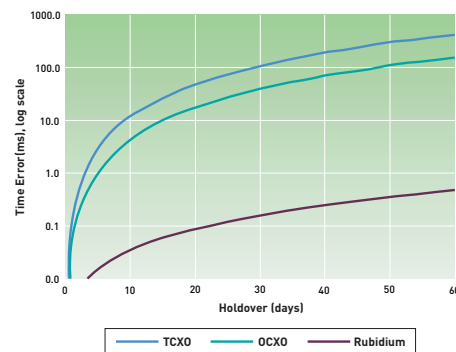

Plot of time error in milliseconds accumulated during holdover for different oscillator types. Note log scale of Y-axis.

SyncServer S250 SPECIFICATIONS

NETWORK PROTOCOLS

- NTP (v2 - RFC1119, v3 - RFC1305, v4 - RFC5905)
- NTP Unicast, Multicast, Broadcast
- SNTP Simple Network Time Protocol (RFC4330)
- TIME (RFC868)
- DAYTIME (RFC867)
- HTTP/SSL/HTTPS (RFC2616)
- SSH/SCP (Internet Draft)
- SNMPv3 (RFC3584)
- Custom MIB
- DHCP (RFC2131)
- Telnet (RFC854)
- MD5 Authentication (RFC1321)
- SMTP Forwarding
- Syslog 1 to 8 servers
- IPv4
- IPv6 and IPv4/IPv6 Hybrid

Key management protocols can be individually disabled.
 LAN 1: Management & Time protocols: LAN 2 & LAN 3: Time protocols only.

SERVER PERFORMANCE

- Stratum 1: 3200 NTP requests per second while maintaining an overall time stamp accuracy of 14 microseconds to UTC with a variation of less than 33 microseconds typical. This accuracy is inclusive of all NTP packet delays in and out of the SyncServer as measured at the network interface. Client synchronization accuracy to server on a LAN is 0.5 - 2 milliseconds (typical). The SyncServer easily supports many hundreds of thousands of NTP clients.
- Stratum 2: Peering can be used as the primary mode of operation or as a back up mode in case the GPS reference signal is lost. Time stamp accuracy depends on NTP peer server(s). NTP request handling capacity remains the same regardless of stratum level.
- Holdover Accuracy/Oscillator Aging

TCXO (standard):	21 milliseconds/day	<1E-06/month
OCXO (optional):	1 milliseconds/day	<1E-07/month
Rubidium (optional):	6 microseconds/day	<5E-11/month

GPS RECEIVER/ANTENNA

- 12 channel parallel receiver
- Minimum number of satellites for time: 1 intermittently
- GPS time traceable to UTC (USNO)
- Accuracy: <50 ns RMS, 150 ns peak to peak to UTC, ≥4 satellites tracked. Network factors can reduce client synchronization accuracy to 0.5-2 ms (typical).
- Maximum Belden 9104 cable length: 150' (45 m). For longer cable runs see Options.

MECHANICAL/ENVIRONMENTAL

- Size: 1.75" x 17" x 11.25"
(4.5 cm x 43.2 cm x 28.6 cm) 1U rack mount
- Power: 100-240 VAC, 50-60 Hz, 25 watts (45 watts with Rb osc.), IEC 60320 C14 connector, power switch.
- Operating temperature: 0°C to +50°C
0°C to +45°C with Rubidium option
- Storage temperature: -10°C to +70°C
- Humidity: To 95%, noncondensing
- Certifications: FCC, CE (RoHS), UL, PSE, China RoHS
- Server weight alone: 8 lbs (3.6 kgs)
- Shipping package weight: 15 lbs (6.8 kgs)

CLIENT SOFTWARE

An NTP client is required for client-side synchronization with any network time server, including the S250. Included with the S250 is Symmetricom's SymmTime NTP client for Windows. Comprehensive time client, server & management software for easy distribution, management and monitoring of time across the network is also available.

Front Panel

- Display: Sharp, high-resolution 32x256 dot-matrix vacuum-fluorescent. 1, 2 or 4 line.
- Keypad: 0-9 numeric, up, down, left, right, ENTER, CLR, TIME, STATUS, MENU.
- LEDs (tri-color green/red/orange)
 - Sync: Time reference status
 - Network: Network connection status
 - NTP: NTP activity
 - Alarm: Fault condition
- Serial: DB9-F 9600, N, 8, 1
- USB: (2x) ports for back up, restore, and upgrade operations via the front panel.

Rear Panel

- Network (3x): RJ-45 10Base-T/100Base-TX Ethernet
- Sysplex: DB9-M RS-232
- GPS: BNC L1, 1575 MHz
- IRIG B AM in: BNC IRIG B 120/121/122/123, IEEE-1344, 1V to 8V p-p, >5KΩ
- IRIG B AM out: BNC IRIG B 123, IEEE-1344 Modulated 3:1, 3.5Vpp, 50Ω Accurate to 10 μS to input TTL, Active rising edge 270Ω
- 1PPS-in: BNC TTL, Rising edge on-time, 50Ω
- 1PPS-out: BNC Sine wave or square wave, 1Vpp to 5Vpp, >50KΩ
- 10 MHz-in: BNC Sine wave >3Vpp & <7Vpp into 50Ω
- 10 MHz-out: BNC Sine wave >3Vpp & <7Vpp into 50Ω

S250 PRODUCT INCLUDES

S250 Network Time Server, L1 GPS antenna, 50' (15 m) Belden 9104 coaxial cable, 1 ft. antenna mounting mast (30 cm) with two clamps, category 5 patch cable, DB9-M to DB9-F RS-232 extension cable, manual, SymmTime NTP client for Windows, Enterprise MIB software, power cord, and rack mount ear kit. Two-year warranty.

S250i PRODUCT INCLUDES (no GPS version)

S250i Network Time Server, category 5 patch cable, DB9-M to DB9-F RS-232 extension cable, manual, SymmTime NTP client for Windows, Enterprise MIB software, power cord, and rack mount ear kit. Two-year warranty.

OPTIONS

[\[To see Options datasheet please click here\]](#)

- Rubidium or OCXO oscillator upgrade for extended holdover
- ±40-60 Vdc power supply
- Window mounted antenna
- GPS antenna in-line amplifier for cable runs to 300' (90 m)
- GPS antenna down/up converter for cable runs to 1500' (457 m)
- Lightning arrestor
- Comprehensive time client, server & management software for easy distribution, management and monitoring of time across the network is also available.
- NTP Network Time Displays, 2" or 4" (5 cm or 10 cm), 6 digit, red LEDs
- IEEE 1588 / PTP see SyncServer S300 or S350



Rear View



Front View



SYMMETRICOM, INC.
 2300 Orchard Parkway
 San Jose, California
 95131-1017
 tel: 408.433.0910
 fax: 408.428.7896
info@symmetricom.com
www.symmetricom.com